

Name: _____

DIRECTIONS: Cut, paste, & sort the shapes that fit under the correct heading.

3D Shapes	2D Shapes

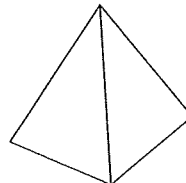
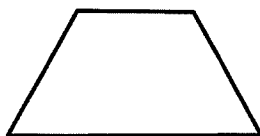
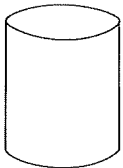
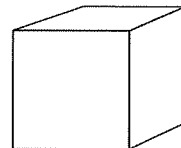
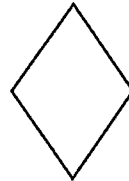
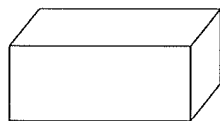
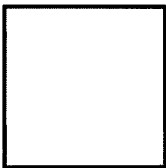
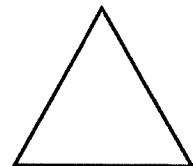
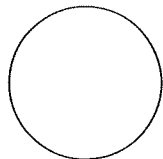
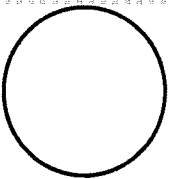

Name: _____

DIRECTIONS: Go on a 3D shape SCAVENGER HUNT. Write and draw the different shapes you find and what they are.

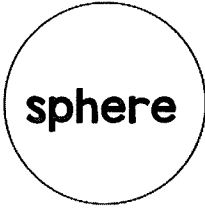
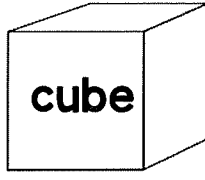
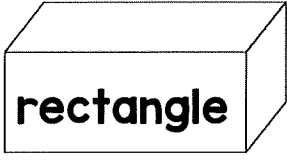
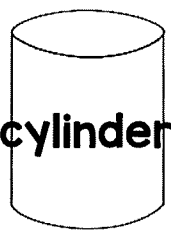
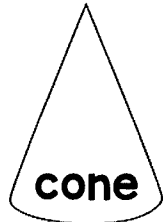
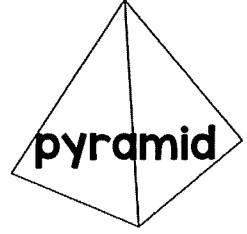
 <p>sphere</p>	
 <p>cube</p>	
 <p>rectangle</p>	
 <p>cylinder</p>	
 <p>cone</p>	
 <p>pyramid</p>	

Name: _____

DIRECTIONS: Cut, paste, & sort the 3D shapes below under the correct heading.

cone	cube	cylinder	sphere	pyramid	rectangular prism

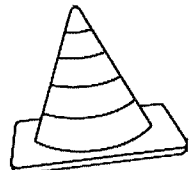
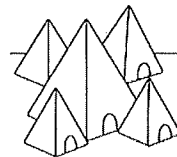
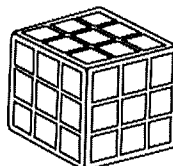
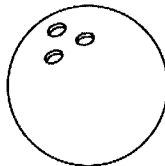
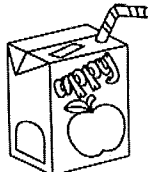
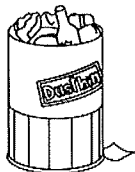
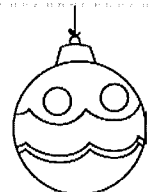
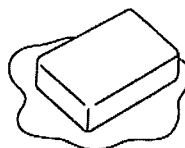
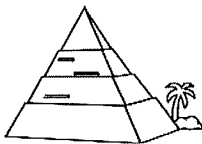
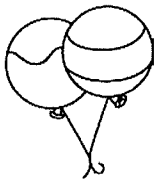
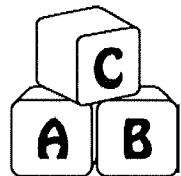
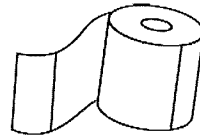
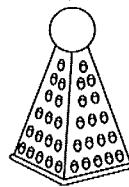
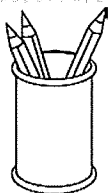
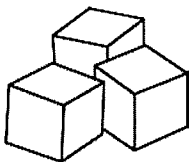

Name: _____

DIRECTIONS: Cut, paste, & sort the 3D figures that fit under the correct heading.

curved surface	no curved surface

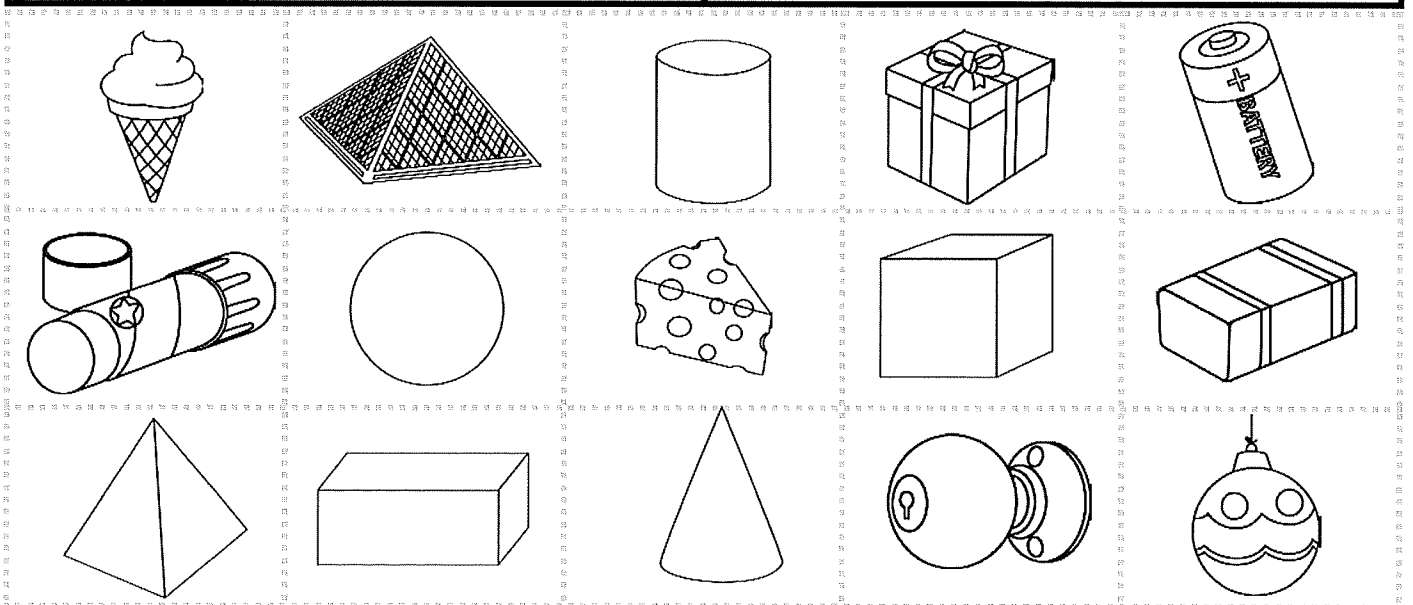

Name: _____

DIRECTIONS: Cut, sort, & paste 3D figures that fit under the defining attribute heading that you label.

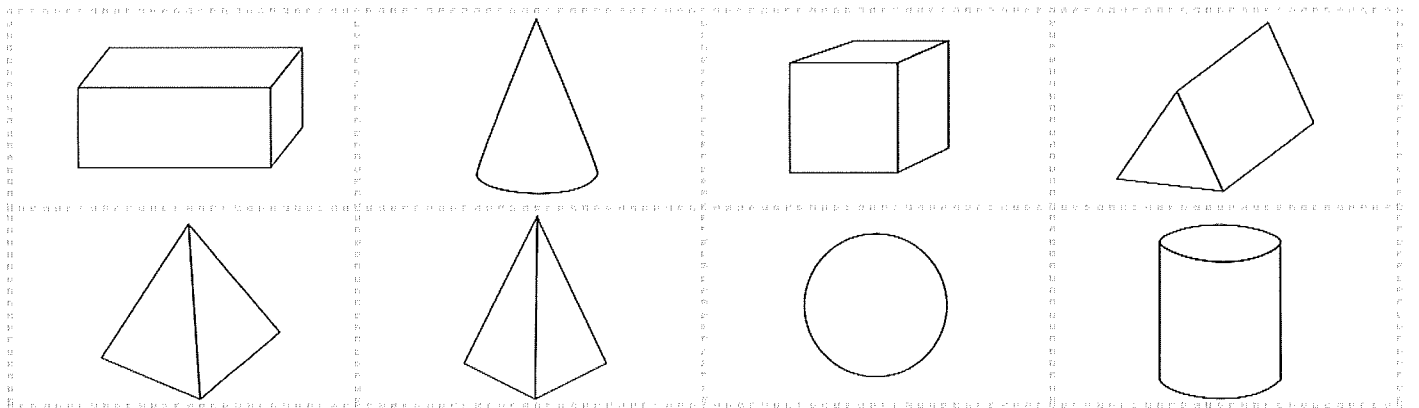

Name: _____

DIRECTIONS: Cut, paste, & sort 2D shapes according to the headings and two attributes listed.

CAN ROLL

CAN STACK

BOTH

